



## FEATURES

- UNIVERSAL INPUT, 5 kHz, CAN POWER THE SENSOR
- TEMPERATURE COMPENSATION FOR GASOLINE OR DIESEL
- NO NEED OF AMPLIFIERS OR LINEARIZERS
- SEVEN DIGIT RATE WITH PROGRAMMABLE DECIMAL PLACES
- THREE SEVEN DIGIT TOTALS WITH PROGRAMMABLE DECIMAL PLACES. ONE NON-RESETTABLE, TWO RESETTABLE
- DISPLAYS TEMPERATURE IN °C OR °F
- SINGLE KFACTOR OR 10 POINT CALIBRATION CURVE
- KFACTORS FROM 0.001 TO 9,999,999
- MILLILITERS, LITERS, GALLONS, CUBIC FEET, CUBIC METERS, ACRE FEET
- PER SECOND, PER MINUTE, PER HOUR, PER DAY
- ISOLATED NO POLARITY 100V/100mA DC/AC OUTPUT THAT CAN BE PROGRAMMED TO BE:
  - RATE ALARM, HIGH OR LOW
  - BATCH OUTPUT WITH A START INPUT
  - TOTAL LIMIT FOR 1 TO 64 DAYS WITH A RESUME INPUT
  - PULSE OUTPUT, UP TO 480 PULSES PER MINUTE (METERING PUMPS)
  - PULSE OUTPUT, UP TO 500 Hz
- 64 DAYS DATALOGGER (TOTAL FOR EACH 24 HOURS)
- ALL SETTINGS STORED IN A NON-VOLATILE MEMORY
- SETTINGS LOCK/UNLOCK FOR SECURITY
- HIGH CONTRAST IN THE ENTIRE TEMPERATURE RANGE
- SIMPLE PROGRAMMING, SMALL SIZE

## APPLICATIONS

- FLOW RATE AND TOTAL MEASUREMENT AND CONTROL OF MANY LIQUIDS INCLUDING GASOLINE AND DIESEL
- BATCH APPLICATIONS
- LIMITING THE TOTAL IN ANY ROLLING PERIOD OF 1 TO 64 DAYS, PROGRAMMABLE
- METERING PUMPS PRECISE CONTROL FOR DOSING APPLICATIONS
- SCADA



## 1. DESCRIPTION

GFC200 is a low power flow computer / totalizer with an universal input and a variety of outputs. It provides power for many types of sensors and accepts their signal to measure flow rate and total of many types of liquids including gasoline and diesel. It precisely corrects the reading for the temperature of the fuel. GFC200 has an isolated no polarity 100V/100mA DC/AC output that can be programmed to work as a rate alarm, high or low, with +/- 1 % hysteresis, batch, limit or pulse output.

Regardless of the type of the output chosen, GFC200 stores up to 64 totals for each 24 hours that can be easily viewed on the liquid crystal display.

For better accuracy GFC200 provides calibration curve capabilities for up to 10 points. In seconds the operator can switch between a single KFACTOR and the curve of up to 10 points.

The GFC200 software implements a version of our proprietary predictive/adaptive, self-adjusting digital filtering which provides extremely stable reading at any input frequency, plus very fast response to any change in the flow.

GFC200 is the perfect solution for flow measurement and control applications that require high accuracy and reliability, temperature correction of the volume measured, high isolation, multi-functionality, small size, industrial grade performance and low maintenance.



## 2. ABSOLUTE MAXIMUM RATINGS \*

Operating temperature	-20 °C to +70 °C <b>The electronics system is industrial (-40 °C to +85 °C) and higher grade . The Liquid Crystal Display (LCD) limits the temperature range.</b>
Power supply voltage	40 VDC
Sensor consumption	20 mA DC
Digital output current	100 mA DC/AC. Alarm, batch, limit or pulse output
Digital output voltage	100 V DC, 70V AC. Alarm, batch, limit or pulse output

\* **NOTE: Stresses above those ratings may cause permanent damage to the device.**

## 3. CHARACTERISTICS

Parameter	Conditions	Min	Typical	Max	Units
<b>Power supply</b>	-20 °C to +70 °C	10.5		36	V DC
<b>Pulse Input</b>					
Voltage for the sensor	Same as the power supply voltage	10.5		36	V DC
Threshold, low	Wave or logical signal (CMOS, TTL etc.)		1		V DC
Threshold, high	Wave or logical signal (CMOS, TTL etc.)		1.4		V DC
Coil voltage	Symmetrical signal from the coil (sine, triangle, saw etc)	20			mVpp
Reed switch current	-20 °C to +70 °C, Powered by GFC 200, Note 1			3.5	mA DC
Frequency, <b>HF</b>	Note 4		5 000		Hz
Frequency, <b>MF</b>	Note 4		1 000		Hz
Frequency, <b>LF</b>	Note 4		200		Hz
<b>Analog Input</b>					
Input current	The span must correspond to -40 to +49 °C, linear	4		20	mA
Input resistance			150		ohm
Transmitter	Connect GTT101-0, PN 30148 or similar				
<b>Digital Output</b>					
Output ON resistance	-20 °C to +70 °C, 100 mA			8	ohm
Output OFF leakage	-20 °C to +70 °C, 100 V DC			5	nA
'Low', pulse rate	Note 2			480	p/min
'Low', pulse duration	Note 2		62.5		ms
'Low', pause duration	Note 2	62.5			ms
'High', pulse rate	Note 3			30,000	p/min

**Note 1:** If the 2 wire sensor uses external power, the external voltage must be 10 V DC or less.

**Note 2:** Pulse output has been programmed to be 'low' – low pulse rate for metering pumps applications. Pulse and pause widths are fixed.

**Note 3:** Pulse output has been programmed to be 'high' – high pulse rate for SCADA, PLCs etc. Pulse and pause have equal widths.

**Note 4:** The values are for reference only. The maximum frequency strongly depends on the duty cycle of the signal and the type of the sensor.



## 3.1. BUTTONS

There are three buttons: **SET** , **UP**  and **RIGHT**  :

- **SET** is used to enter and exit menus and confirm options chosen
  - **UP** is used to change the data
  - **RIGHT** is used to move the cursor (blinking digit or icon) to the right
- Additional button functions:

There are two types of buttons accepted by the GFC200 flow computer / totalizer:

- Short is when the button is pressed and released in less than 0.5 second
- Long is when it is kept pressed for more than 5 seconds
- All other durations are ignored

**NOTE: The UP button will not change the value if the settings are locked.**

## 3.2. INPUTS

GFC200 has three inputs:

- Pulse input from a flow sensor such as wave, logical signal, open drain/collector, npn/pnp, reed switches, dry contact, turbine meters, coils and others. The computer / totalizer has all pull-up/down, current limiting and signal conditioning circuits built-in. The input also provides power for all types of sensors. There is no need to use external amplifiers for the coils if they provide more than 20 mVpp signal.
- Start/pause/resume input. This input is used for batch and limit applications with the output of GFC200 programmed as batch or limit. The intended use of this input is to connect to it a normal open push button, dry contact or an open drain sinking output. If the output of GFC200 is programmed as alarm or pulse, this input is ignored.
- Analog 4-20 mA input providing signal from GTT101-0 linear to the temperature in the range of -40 to +49 °C. This signal is precisely measured, converted to temperature and is used to correct the volume measured. The software provides correction for gasoline and diesel only. The correction can be disabled. If this input is not connected the correction must be disabled in the special menu.

## 3.3. OUTPUTS

GFC200 has one isolated output:

### 3.3.1. Digital output

The isolated digital output has no polarity, can work with 100V/100mA and can be programmed to be:

- Rate alarm, high or low, with +/- 1% hysteresis.  
**Example:** If the alarm is programmed at 100.00 GPM and to be **high** the output will turn on when the flow rate exceeds 101.00 GPM and will turn off when it drops below 99.00 GPM.  
With **low** alarm the action will be reversed.
- Batch total  
**Example:** The batch amount is programmed at 1000.0 G. The **total B** shows the batch amount accumulated and is not resettable. When **total B** reaches or exceeds 1000.0 G, the digital output turns



ON and **total B** stops increasing. Pressing the push button for more than 0.5 seconds will clear **total B**, turn the digital output OFF and **total B** will start accumulating next batch amount. Pressing the push button before reaching 1000.0 G will pause the batch (**total B** not accumulating, output ON). Pressing it again will resume the batch (output OFF, **total B** accumulating).

- Limit total. This feature can limit the total for any rolling number of days programmed.  
**Example:** To limit the total of water used to 200 gallons a week, program the limit to 200 gallons and the DAYS to 7. If the total in any rolling 7 days exceeds 200 gallons, the output will turn on and can shut the master valve off or perform another function. The output will stay on until the resume input (connected to a push button, switch etc.) is shorted. The total used is checked against the limit once a day, 24 hours after the previous check.
- Pulse output. This feature is intended for use with metering/dosing pumps, SCADA, PLCs and other devices.

The pulse output can be programmed for **low** or **high** pulse rate.

- When **low** it provides pulses with duration of 62.5 ms and pause longer than 62 ms. The output pulse rate is limited to about 480 pulses per minute for use with metering/dosing pumps.
- When the pulse output has been programmed for **high** rate it can provide up to 30,000 pulses per minute (500 Hz) with equal duration of the pulse and the pause.

**Example:** You are adding chlorine or fertilizer to the water and have connected the control input of a pump to this pulse output. You program the "**SETP**" factor at 3.762 Gallons per pulse. The pump will produce one pulse every 3.762 gallons and add the chlorine or the fertilizer in an exact proportion to the water.

### 3.4. DISPLAY

The liquid crystal display (LCD) has 7 digits with 1, 2 or 3 decimal places and many icons. It shows rate, total, temperature and all the variables and options that can be set or programmed. The rate and the totals have programmable auto, none, 1, 2 or 3 decimal places.

GFC200 software implements our latest proprietary algorithms for predictive / adaptive, self-adjusting digital filtering of the rate. It provides exceptionally stable reading at any input frequency, plus very fast response to any change in the flow.

A "**FLOW**" icon will always be displayed.

When the display shows rate, a "**RATE**" icon is displayed. If it shows total a "**TOTAL**" icon will be displayed along with "**A**", "**B**" or "**C**" (GFC200 has three totals).

When input pulses are present, an "**INP**" (input) icon will be displayed.

When the digital output is ON an icon for cause will be displayed (**alarm, batch, limit** or **pulse**)  
If the total on the LCD is allowed to be reset, a "**RESET**" icon will be displayed.

#### 3.4.1. Volume and time units

- Milliliters (**mL**), liters (**L**), gallons (**G**), cubic feet (**CF**), cubic meters (**M<sup>3</sup>**) and acre feet (**AF**) per second (**S**), minute (**M**), hour (**H**) and day (**D**) are available.



### 3.4.2. Normal mode

Automatically after turning the power on or exiting a menu, GFC200 enters the normal mode. Normal mode displays:

- Rate
- Total A, B or C. Total A reset can be enabled or disabled. It is stored in a non-volatile memory every 50 seconds or immediately when cleared.  
Total B in batch mode for the output is non-resettable. It is the total that is compared against the preprogrammed batch volume.  
If a total is allowed to be reset, the **RESET** icon is shown. Reset a total with long **RIGHT** button.
- Temperature in °C or °F (programmable)
- To switch between rate, total A, B, C and temperature use short **UP** button.

### 3.4.3. Menus

To enter the menus, use long **SET** button in normal mode. About 5 seconds after holding the **SET** button, the first menu will appear on the LCD:

- **KFACTOR** icon along with **dp 1234** is shown. The decimal places for all **KFACTOR**s (single **KFACTOR** and all **KFACTOR**s in the calibration table) can be programmed using **UP** button. **KFACTOR**s ranging from 0.001 to 9,999,999 can be entered this way.

Use short **SET** to move to the next menu.

- **KFACTOR** icon is shown. The main **KFACTOR** for the particular **FLOW** meter connected to the GFC200 can be entered using **UP** and **RIGHT**. This is how many pulses the flow computer will receive for one gallon. While in this menu all the settings can be locked/unlocked. Use **RIGHT** button to move the cursor to the furthest digit on the right and then use long **SET**.
  - Use short **UP** to lock/unlock the settings. Then use short **SET** to go back to **KFACTOR** menu.
  - If the settings are locked, they can be viewed, not changed.

From the **KFACTOR** menu use short **SET** to enter the next menu. NOTE: the computer will not accept zero for the **KFACTOR**.

In the **CUrve** menu, use short **UP** to change between blinking **CUrve** and blinking **KFACTOR**. The flow computer will use either the single **KFACTOR** or the calibration **CUrve** of up to 10 points for calculations. The points have to be entered before using the calibration curve. The factory default is 1.0 for the **KFACTOR** of each point. The curve is stored in a non-volatile memory, and the points can be entered in any order. The computer will order and validate them.

- Enter the calibration data mode by using long **SET** in the **CUrve** menu for either a blinking **CUrve** or **KFACTOR**.
- “**CAL Crv**” will appear on the LCD, and “**NO**” icon will be blinking. To continue choose **YES** and press short **SET**. To leave calibration curve data mode and leave the previous calibration data untouched, choose **NO** and press short **SET** to go back to the **CUrve** menu.

This feature is very useful for flow meters that have a calibration sheet provided by the manufacturer or the calibration laboratory. Each point consists of an input frequency and a **KFACTOR** (in pulses per gallon) for that frequency.

**Once you enter the calibration curve data menu, you have to go to the last point (point 9).**



**If you have data for less points enter 0.0 for the frequency for all unused points. GFC200 will not accept 0.0 for any KFACTOR.**

If **YES** has been chosen, “**Point 0**” will appear on the LCD. Press short **SET** and enter the input frequency in Hz for point 0. Press short **SET** and then enter the KFACTOR for that input frequency. Press short **SET** to do the same for the next point.

Repeat the above for up to 9 more points. After point 9, the flow computer will automatically return to the **CUrve** menu.

- There is no need to enter the frequency at each point in a special (ascending/descending) order. The computer will automatically sort and validate the data and calculate all the parameters..

In the **CUrve** menu press short **SET** to move to **Correction** menu.

- In the **Correction** menu choose among **none**, **GAS** and **diESEL**. Press short **SET** to move to the **degree type** menu where you can choose the units for the temperature between °C and °F.

Use short **SET** to move to the “**volume units menu.**”

- In the “volume units” (**vU**) menu, use **UP** to choose the volume units among **mL**, **L**, **G**, **CF**, **M<sup>3</sup>** and **AF**. Press short **SET** to move to the “**time unit menu.**”
- In the “time unit” (**tU**) menu, use **UP** to choose the time units among **S**, **M**, **H** and **D**. Press short **SET** to move to the “**OUT Type**” menu.
- In the output type menu, use **UP** to choose the type of the output among **alarm**, **batch**, **limit** and **pulse**. Press short **SET** to move to the next menu or press long **SET** to enter the **DATALOG** menu.

\* If **alarm** has just been chosen, the next menu will be the “**alarm type**” menu where using **UP** button **high** or **low** alarm can be chosen. Press short **SET** to move to the **alarm value** menu.

\* If the **limit** output has been chosen, the next menu will be **DAYS** menu where the rolling number of days for the limit can be entered.

\* If the **pulse** menu has been chosen the next menu will be **Pulse Type** (high/low). Use **low** pulse output for metering/dosing pumps with up to 480 strokes per minute. Use **high** pulse output to connect to a PLC, SCADA or other device that can accept up to 30 000 pulses per minute (500 Hz). Use short **SET** to move to **SETP** menu.

- In the **output value** menu:
  - The value of the **alarm** must be in **G/M**
  - The value of the **batch** must be in **GALLONS**, and it will compare to the **total B**
  - The value of the **limit** must be in **GALLONS**
  - The value for **SETP** must be in **GALLONS PER PULSE**

**Note that the computer will not accept zero for those settings.**

- Press short **SET** to move to the “Rate **decimal Places**” menu where (using short **UP**) auto, none, 1, 2, or 3 decimal places for the rate can be programmed.
- Press short **SET** to move to the “Total **decimal Places**” menu where (using short **UP**) auto, none, 1, 2, or



3 decimal places for all totals can be programmed.

- Press short **SET** to move to the **Total A Reset enable/disable** menu. In this menu using **UP** button the total A reset can be enabled or disabled. If enabled and GFC200 is in normal mode displaying total A, the **RESET** icon will also be displayed and long **RIGHT** will clear total A.

Because this is the last menu, pressing long **SET** will move the computer to the **LOCK** menu. Use **UP** to lock the settings and press short **SET** to go back to **Total A Reset enable** menu. General practice would be to unlock the settings at the **KFACTOR** menu. Settings can be changed changed and locked again before exiting at the last menu . Press short **SET** to exit. After a couple of seconds during which all the settings are checked, validated and stored into the non-volatile memory, the computer will return to the normal mode.

**NOTE: The software time out feature will reset the computer and force it to the normal mode WITHOUT saving any changes made in any of the menus. The changes will only be saved after exiting the Total A Reset enable menu by pressing short SET.**

**NOTE: Even in menu mode, the computer always continues to measure and calculate rate and total and control the output so no total will be lost. In some circumstances, such as changing the KFACTOR, the total accumulated will be invalidated. The user must take appropriate actions after changing the settings, such as resetting the total for an instance.**

- If long **SET** has been pressed in the **output type** menu, the computer will move to the **DATALOG** menu. “**DAYS back 00**” will appear on the LCD. Pressing **UP** will display the total after the last full 24 hours. Pressing **RIGHT** will bring back the **DAYS back XX** menu. Pressing **RIGHT** again will increment the **days back** number. The totals for up to 64 previous days are available. This feature can be useful with the limit output, allowing the user to check the total water used per day and to determine when the limit was exceeded.
- Pressing short **SET** will move the computer to the **DATALOG RESET** menu. Choose **YES** or **NO** using **UP** button. Choosing **YES** will reset the data log to zero for all totals (1 to 64 days back).
- Press short **SET** to move to the **DTALOG INIT** menu. Choosing **YES** will initialize the data log – all the totals for all days back will remain untouched but the time for completing 24 hours total will change to the moment at which the short **SET** after **YES** was pressed. After the short **SET**, the computer will return to the **OUTput TYPE** menu.

**Example:** The owner did a **DATALOG INIT** at 11 o'clock. Exactly at the same time each day the total for the last 24 hours will be stored and a new cycle will start.

### 3.5. Checking the LCD

All the icons of the LCD can be checked by pressing and holding the **RIGHT** button while powering on or after exiting the last menu. Releasing the button will return the computer to normal mode.

### 3.6. Removing the power

**Total A is stored in the non-volatile memory every 50 seconds.**  
**Before removing the power make sure that there was no flow for the last minute.**

### 4. MENU DIAGRAM

The menu diagram for GFC200 flow computer / totalizer is shown below.

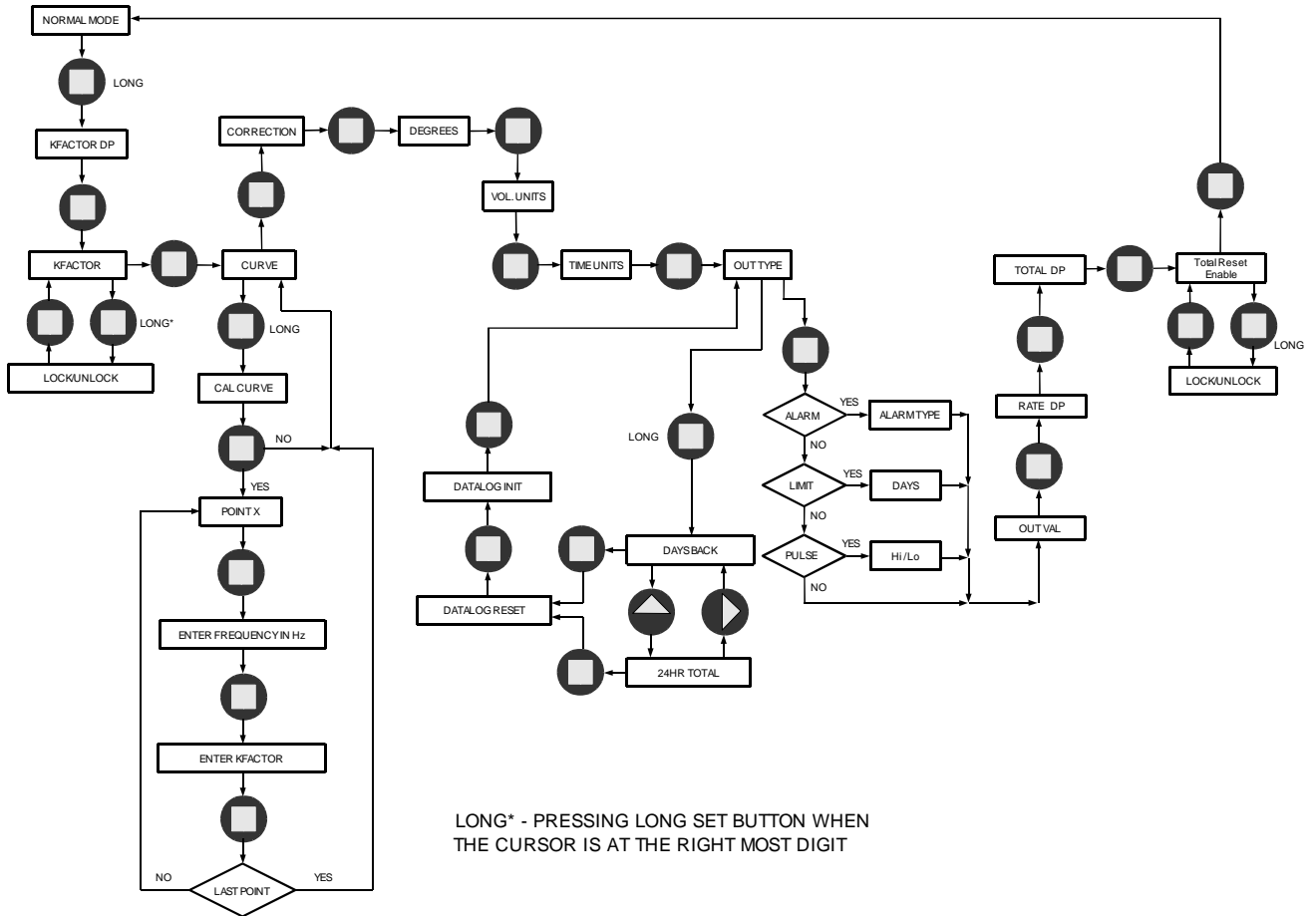

## 5. APPLICATION

### 5.1. ELECTRICAL

The wiring diagram is shown below.

**NOTE: There is no isolation between the inputs and the power supply. Terminals 2, 5 and 8 are shorted inside the device. It is the user's responsibility to consider this fact and implement appropriate wiring in the user's specific application.**

- 1 – Power supply plus
- 2 – Power supply minus
- 3 – Power for the sensor, plus
- 4 – Signal/Coil
- 5 – Power for the sensor, minus
- 6 – Coil, only
- 7 – Push button plus
- 8 – Push button minus
- 9, 10 – Digital output, no polarity
- 11 – Analog input plus
- 12 – Analog input minus

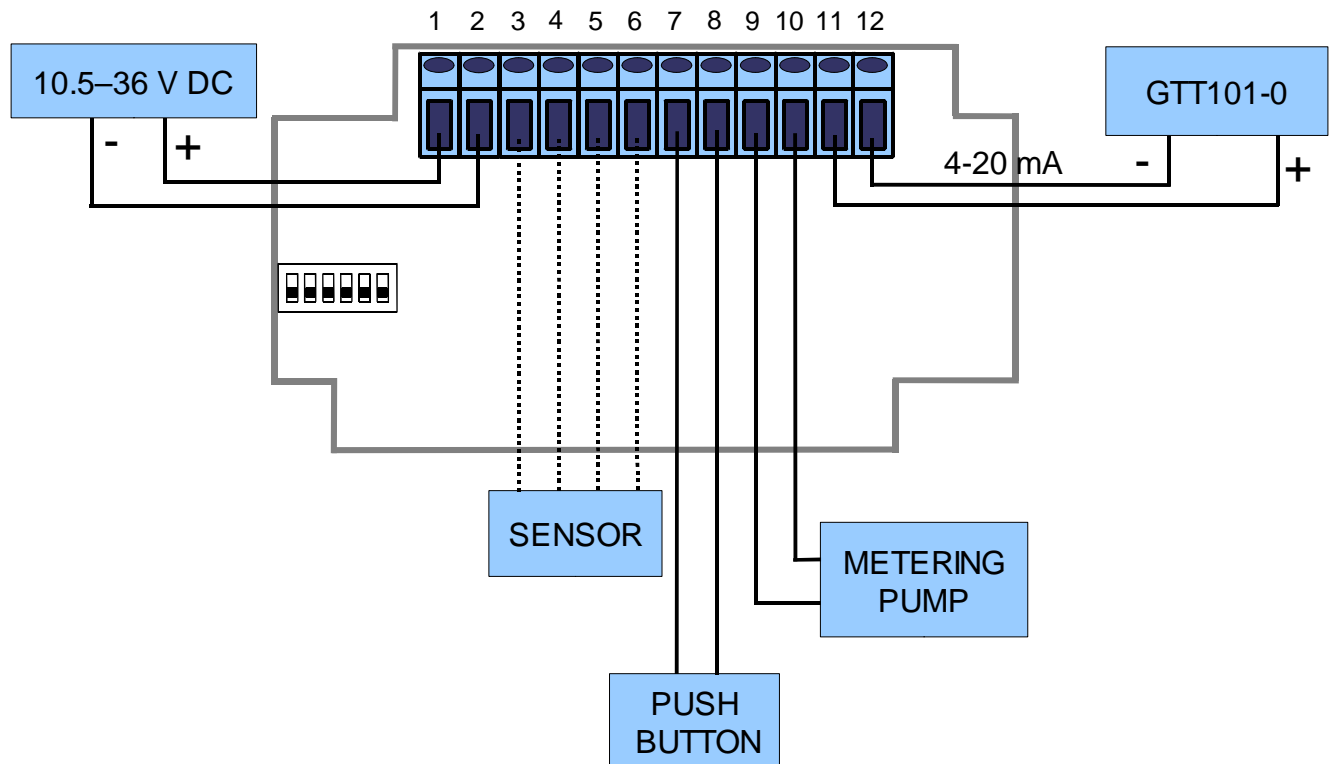

5.1.1. Wiring the sensor

GFC200 accepts a variety of sensors. See below for wiring specifications and their particular wiring is shown below:

5. NPN Open Drain, Open Collector

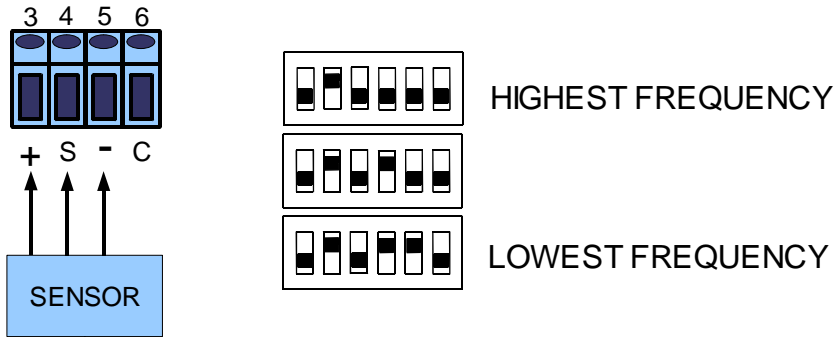

5.1.1.2. PNP Open Drain, Open Collector

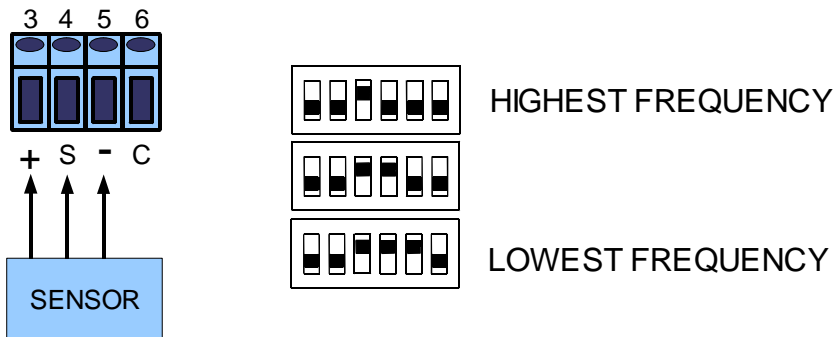

5.1.1.3. Reed Switch, Dry Contact



**NOTE: Different reed switches and dry contacts have different bouncing time. Test and evaluate carefully to determine the right DIP switch setting.**

5.1.1.4. Wave (square, sine, triangle, saw etc.), Logical Signal (CMOS, TTL etc.)

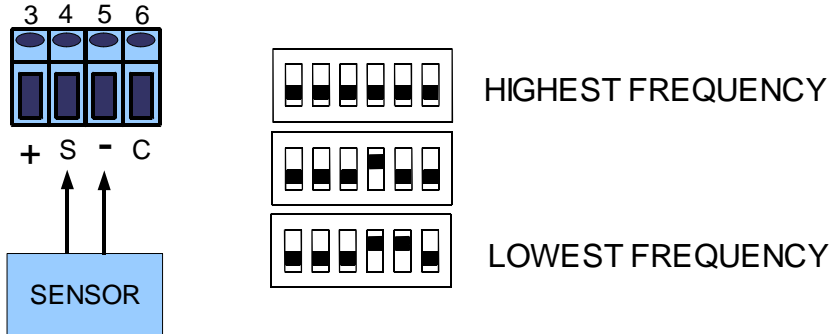

5.1.1.5. Coils

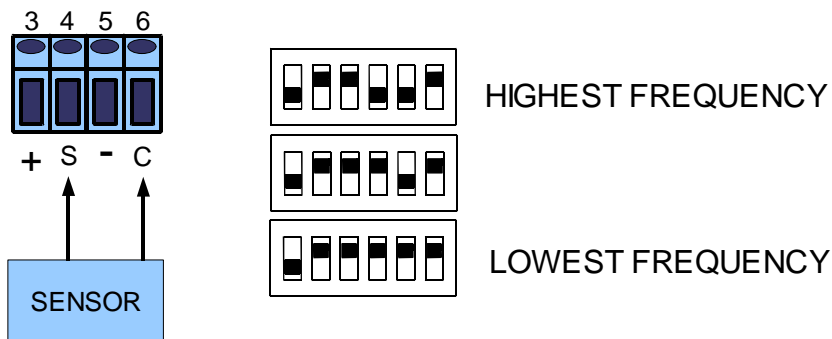

**NOTE: If the cable to the coil is shielded, connect the shield to “-” (terminal 5) ONLY. Do not connect the shield to anything at the other (coil) end of the cable. The shield has to be isolated from earth ground and all other equipment or electrical connections.**

## 5.2. MECHANICAL

Mounting GFC200 on a wall requires an area of 120 x 65 mm (4.73 x 2.56 inches) and two screws:

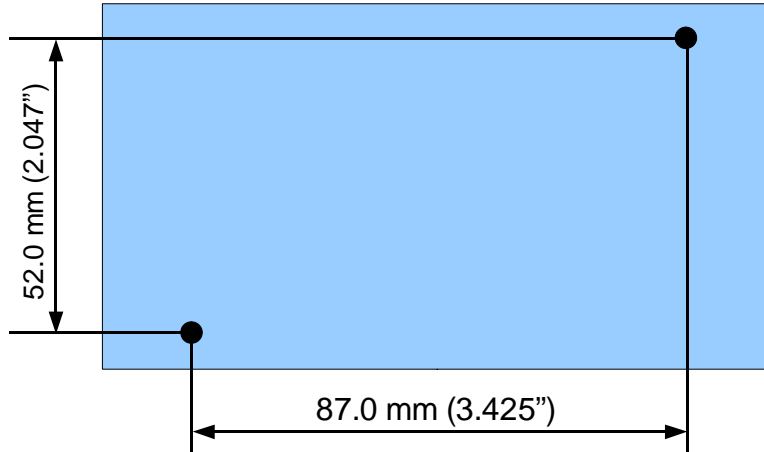

NOTE: The cable grips and the cables need additional space

## 6. ORDERING

For ordering please use the following G Instruments part numbers:

<i>Description</i>	<i>G Instruments PN</i>
GFC200 flow computer (external isolated 10.5 – 36 V DC needed)	30172
GFC200 flow computer with GPS115 (115 VAC power supply)	30173
GFC200 flow computer with GPS220 (220 VAC power supply)	30174
GFC200 flow computer with GPS122 (85-264 VAC power supply)	30238
GTT101-0, -40 to +49° C, Pt100, alpha = 0.00385 temperature transmitter	30148



## IMPORTANT NOTICE

G Instruments reserves the right to make corrections, modifications, enhancements, improvements and other changes to its products at any time without notice.

Customers should obtain the latest relevant information before placing orders and should verify that such information is current and complete.

G Instruments does not assume any liability arising from the use of any device or circuit described herein, nor does it convey any license under its patent rights or the rights of others.

Customers are responsible for their products and applications using G Instruments devices. To minimize the risks associated with customer products and applications, customers should provide adequate design and operating safeguards.

G Instruments products are not authorized for use as critical components in life support devices or systems without express written approval of G Instruments.

Trademarks and registered trademarks are the property of their respective owners.